

ShoreTel® 565g IP Phone

Quick Install Guide & Warranty



Document and Software Copyrights

Copyright © 1998–2009 by ShoreTel, Inc., Sunnyvale, California, U.S.A. All rights reserved. Printed in the United States of America. Contents of this publication may not be reproduced or transmitted in any form or by any means, electronic or mechanical, for any purpose, without prior written authorization of ShoreTel, Inc.

ShoreTel, Inc. reserves the right to make changes without notice to the specifications and materials contained herein and shall not be responsible for any damage (including consequential) caused by reliance on the materials presented, including, but not limited to, typographical, arithmetic, or listing errors.

Trademarks

ShoreTel[®], ShoreCare[®], ShoreWare[®], ShoreGear[®] and ControlPoint[®] are registered trademarks of ShoreTel, Inc. in the United States and/or other countries. ShorePhone[™] is a trademarks of ShoreTel, Inc. in the United States and/or other countries. All other copyrights and trademarks herein are the property of their respective owners.

Patents

This product is covered by one or more of the following patents: United States Patent 6,996,059, United States Patent 7,003,091, United States Patent 7,167,486, United States Patent 7,379,540, and United States Patent 7,386,114. ShoreTel, Inc. All rights reserved.

Version Information

PN 800-1100-02
ShoreTel 565g IP Phone Quick Install Guide & Warranty
Date: January 6, 2009

Company Information

ShoreTel, Inc.
960 Stewart Drive
Sunnyvale, California 94085
USA

Phone: +1.408.331.3300 OR +1.800.425.9385
Fax: +1.408.331.3333

www.shoretel.com

Installing Your ShoreTel 565g IP Phone

This section shows how to install a ShoreTel 565g IP Phone. Instructions are provided for connecting phones with and without the AC power adapter. (This adapter may be necessary for networks that do not support the IEEE 802.3af standard for Power-over-Ethernet).

Package Contents

ShoreTel 565g IP Phone

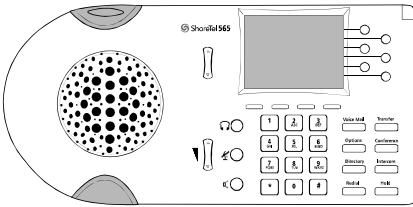

Handset & handset cord

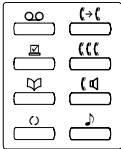
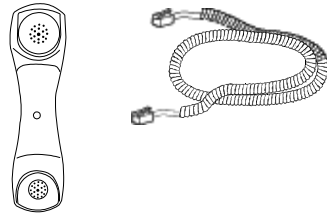

Vinyl overlay with international symbols (for Function Keys)

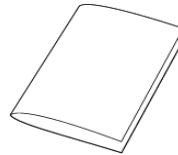

Quick Install Guide

Phone base

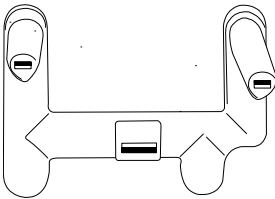

Network cable with ferrite EMI filter

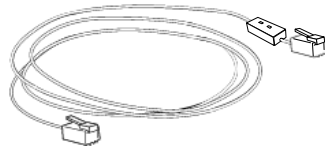

Spare "snap-on" ferrite EMI filter



AC Power Adapter Package (Optional)

Power-over-Ethernet adapter and power cord

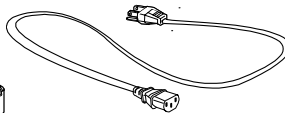
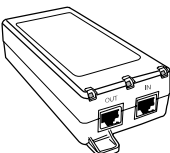

Additional network cable (7-foot)

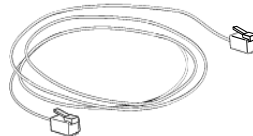

Note: In order to achieve gigabit performance when using a power adapter with the 565g, a gigabit-capable adapter is needed.

1 Attach phone to base

a Connect the base to the larger of the three tabs on the back of the phone.

b Rotate the two pillars down onto the smaller tabs and snap into place.

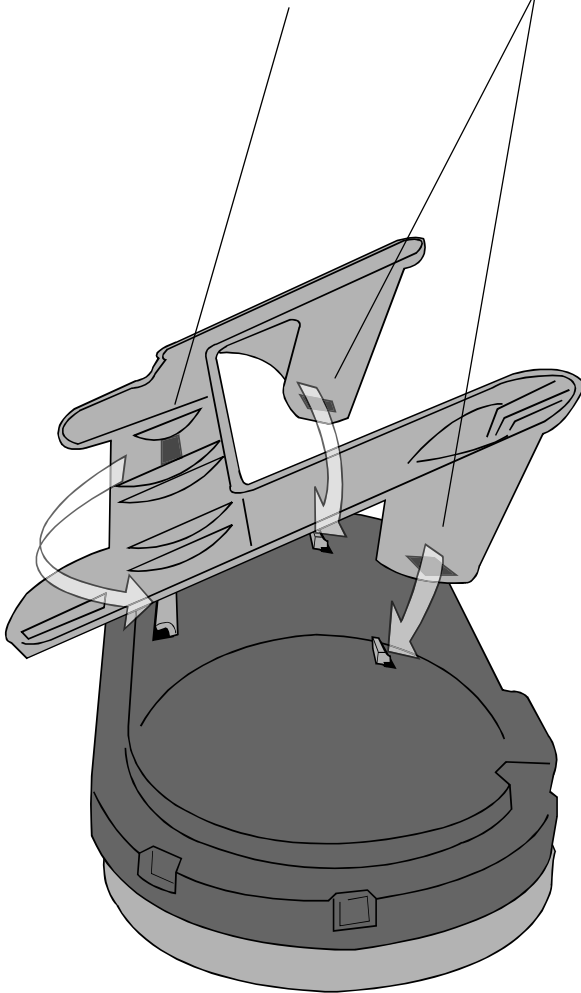

2a Connect to powered network

(no AC adapter required)

If the LAN to which this phone will be connected supports power-over-Ethernet, no AC adapter is needed. The phone draws power from the Ethernet network.

Connect the network cable between the LAN port on the back of the phone and an Ethernet jack in the workspace (or on a data switch/router that supports Power-over-Ethernet).

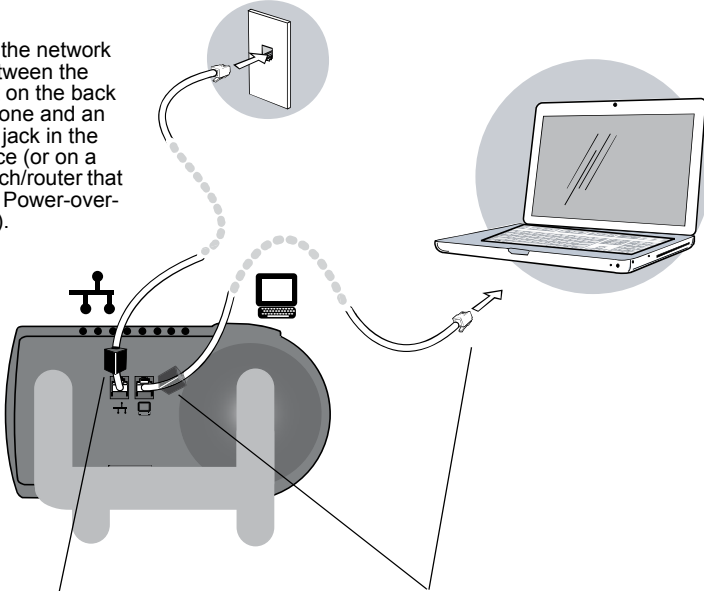

To prevent electro-magnetic interference, make sure to connect the included Ethernet cable to the phone such that the ferrite EMI filter is closer to the phone.

optional

If desired, you can daisy-chain a PC off the second Ethernet port on your phone, with the phone and computer sharing a single LAN wall jack (as shown).

If you choose this optional configuration, you must attach the spare ferrite EMI filter (included) to an Ethernet cable (not included) such that the filter is within 1 to 2 inches of the body of the phone. This is to prevent the leakage of electro-magnetic radiation.

2b Connect to power & network

(Non-powered Ethernet network requires AC power adapter)

- c** Connect the AC power cable between the adapter and an electrical socket.

LED lights green to indicate that phone is connected and using power.

LED lights red to indicate there is a fault.

LED lights green to indicate adapter has AC power.

- b** Connect the second network cable to the DATA IN port** on the adapter and an Ethernet jack in the workspace (or on a data switch/router).

- a** Connect a network cable to the DATA & POWER OUT port* on the adapter.

Connect the other end to the LAN port on the phone (with the ferrite EMI filter next to the phone).

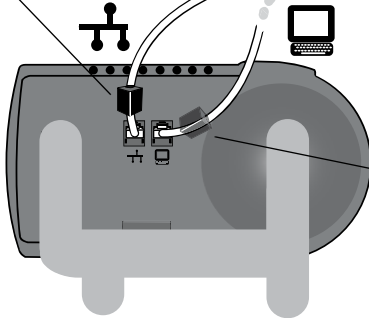

optional

If desired, you can daisy-chain a PC off the second Ethernet port on your phone, with the phone and computer sharing a single LAN wall jack (as shown).

* ON SOME ADAPTERS, THIS PORT MAY BE LABELED "DATA & PWR" OR "PHONE."

** ON SOME ADAPTERS, THIS PORT MAY BE LABELED "DATA" OR "NETWORK."

3 Connect handset

For optimal use, attach the longer end of the handset cable to the handset.

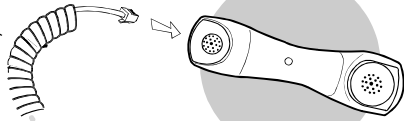

Connect the short end of the handset cable to the jack on the phone body.

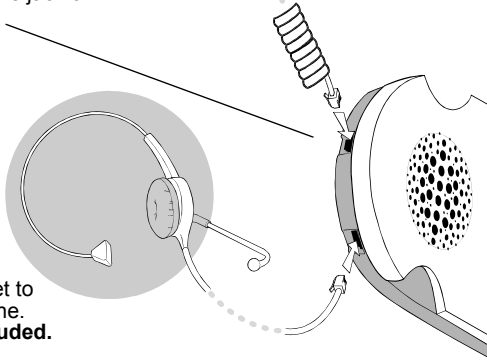

optional

Connect a headset to connector on phone.
Headset not included.

Wireless Headset Support: Bluetooth

The 565g IP phone supports various Bluetooth wireless headsets. Please contact your ShoreTel representative for the latest list of supported models.



Wireless Headset Support: Electronic Lifter

The 565g IP phone has an internal electronic handset lifter, allowing some wireless headsets to be used without a mechanical lifter.



Choosing Bluetooth Headsets for the IP 565g phone

The IP 565g phone supports the Bluetooth V2.0 standard, which is backwards-compatible with Bluetooth 1.x headsets. Compatible headsets need to support the hands-free or headset profile, as defined in the Bluetooth standard.

Even though internal testing of third-party headsets for the IP 565g has been performed, ShoreTel does not certify or support products from headset vendors. Because of the inherent environmental inconsistencies in the locations in which the IP 565g may be deployed, there is no one best headset solution that is optimal for all environments. ShoreTel recommends that customers test the headsets that work best in their environment before deploying a large number of units in their network.

The primary reason that support of a Bluetooth headset would be inappropriate for an installation is the potential for undesired noise, such as crackling or popping sounds. Such noise may be heard by the remote party or by both the remote party and the IP 565g user. Causes for the noise can include:

- 1 Using the Bluetooth at or beyond the limits of the supported range (i.e. 30 ft)
- 2 Having physical objects obstruct the "line of sight" between the IP 565g and the user wearing the Bluetooth headset.
- 3 Operation of 2.4 GHz Wi-Fi network (802.11 b/g) in the same location as the IP 565g.
- 4 Microwave ovens or other cordless phones operating in the 2.4 GHz band.

In some instances, the mechanics or electronics of various headsets can cause remote parties to hear their own voices echo back when they speak to IP 565g Bluetooth users. Sometimes this can be mitigated by turning down the volume setting of the phone and/or headset.

Testing performed in the ShoreTel labs has shown that the Plantronics 510 and Plantronics 655 have performed well with the IP 565g, but it remains the customer's responsibility to test in their environment.

Important Safety Instructions

For IP TELEPHONE, MODELS 110, 115, 212k, 230, 265, 560, 560g, 565g and BB24



This symbol is to alert you to important operating or servicing instructions that may appear in this owner's manual.

Always follow basic safety precautions when using this product to reduce the risk of injury, fire, or electric shock.

- Read and understand all instructions in this manual. Observe all markings on the products.
- Follow all warnings and instructions marked on this product.
- For information on proper mounting instructions, consult the manual provided with this product.
- This product should be operated only from the type of power source indicated on the marking label.
- Telecommunication metallic-type connections are not intended to leave the building premises unless connected to other telecommunication devices that provide primary and secondary protection as applicable.
- To reduce the risk of electrical shock, do not disassemble this product. Service should be performed by trained personnel only. Opening or removing covers and/or circuit boards may expose you to dangerous voltages or other risks. Incorrect re-assembly can cause electrical shock when the unit is subsequently used.
- If this product has a three-prong (grounding) plug or a polarized plug with one wide prong, it may not fit in non-polarized outlets. Do not defeat the purpose of these plugs. If they do not fit in your outlet, the outlet should be replaced by an electrician.
- Install this product in a protected location where no one can trip over any line or power cord. Protect cords from damage or abrasion.
- Unplug this product from the wall outlet before cleaning. Do not use liquid cleaners or aerosol cleaners. Use a damp cloth for cleaning.
- Do not allow anything to rest on the power cord. Do not locate this product where the cord will be abused by persons walking on it.
- Do not overload wall outlets and extension cords as this can result in the risk of fire or electrical shock.
- Unplug this product from the wall outlet and contact qualified technicians to service the unit if the any of the following conditions occur:
 - a) When the power supply cord or plug is damaged or frayed.
 - b) If liquid has been spilled into the product.
 - c) If the product has been exposed to rain or water.
 - d) If the product does not operate normally by following the operating instructions. Adjust only those controls that are covered by the operating instructions because improper adjustment of other controls may result in damage, and will often require extensive work by qualified technician to restore the product to normal operation.
 - e) If the product has been dropped and exhibits a distinct change in performance.
- Warning: Small metal objects may be retained in the earcap region.

SAVE THESE INSTRUCTIONS

Features and Functions

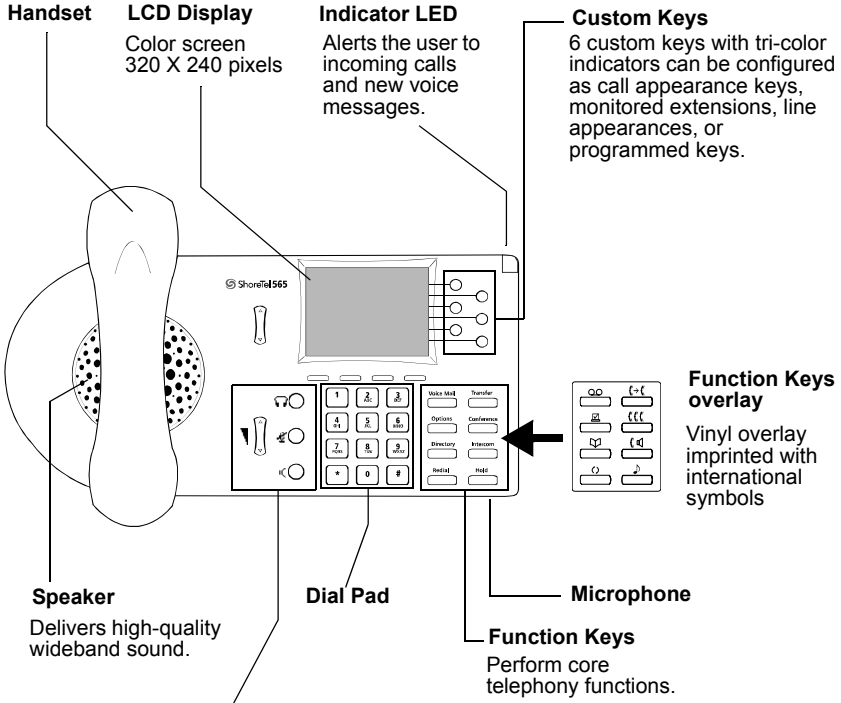

Note: You can access the latest user guide for this phone by downloading a PDF from the following URL: www.shoretel.com/phoneguides

Warranty and Limitation of Liability

LIMITED WARRANTY. ShoreTel warrants to the end user (“Customer”) that this product will be free from defects in workmanship and materials, under normal use and service, for one year from the date of purchase from ShoreTel or its authorized reseller. ShoreTel's sole obligation under this express warranty shall be, at ShoreTel's option and expense, to repair the defective product or part, deliver to Customer an equivalent product or part to replace the defective item, or if neither of the two foregoing options is reasonably available, ShoreTel may, in its sole discretion, refund to Customer the purchase price paid for the defective product. All products that are replaced will become the property of ShoreTel. Replacement products or parts may be new or reconditioned. ShoreTel warrants any replaced or repaired product or part for ninety (90) days from shipment, or the remainder of the initial warranty period, whichever is longer.

Products returned to ShoreTel must be sent prepaid and packaged appropriately for safe shipment, and it is recommended that they be insured or sent by a method that provides for tracking of the package. Responsibility for loss or damage does not transfer to ShoreTel until the returned item is received by ShoreTel. The repaired or replaced item will be shipped to Customer, at ShoreTel's expense, not later than thirty (30) days after ShoreTel receives the defective product, and ShoreTel will retain risk of loss or damage until the item is delivered to Customer.

EXCLUSIONS. ShoreTel will not be liable under this limited warranty if its testing and examination disclose that the alleged defect or malfunction in the product does not exist or results from:

- Failure to follow ShoreTel's installation, operation, or maintenance instructions.
- Unauthorized product modification or alteration.
- Unauthorized use of common carrier communication services accessed through the product.
- Abuse, misuse, negligent acts, or omissions of Customer and persons under Customer's control or
- Acts of third parties, acts of God, accident, fire, lightning, power surges or outages, or other hazards.

WARRANTY EXCLUSIVE. IF A SHORETEL PRODUCT DOES NOT OPERATE AS WARRANTED ABOVE, CUSTOMER'S SOLE REMEDY FOR BREACH OF THAT WARRANTY SHALL BE REPAIR, REPLACEMENT, OR REFUND OF THE PURCHASE PRICE PAID, AT SHORETEL'S OPTION. TO THE FULL EXTENT ALLOWED BY LAW, THE FOREGOING WARRANTIES AND REMEDIES ARE EXCLUSIVE AND ARE IN LIEU OF ALL OTHER WARRANTIES, TERMS, OR CONDITIONS, EXPRESS OR IMPLIED, EITHER IN FACT OR BY OPERATION OF LAW, STATUTORY OR OTHERWISE, INCLUDING WARRANTIES, TERMS, OR CONDITIONS OF MERCHANTABILITY, FITNESS FOR A PARTICULAR PURPOSE, SATISFACTORY QUALITY, CORRESPONDENCE WITH DESCRIPTION, AND NON-INFRINGEMENT, ALL OF WHICH ARE EXPRESSLY DISCLAIMED. SHORETEL NEITHER ASSUMES NOR AUTHORIZES ANY OTHER PERSON TO ASSUME FOR IT ANY OTHER LIABILITY IN CONNECTION WITH THE SALE, INSTALLATION, MAINTENANCE, OR USE OF ITS PRODUCTS.

SERVICE AGREEMENTS. Please contact your ShoreTel Authorized Reseller for information about service agreements applicable to your product.

LIMITATION OF LIABILITY. TO THE FULL EXTENT ALLOWED BY LAW, SHORETEL EXCLUDES FOR ITSELF AND ITS SUPPLIERS ANY LIABILITY, WHETHER BASED IN CONTRACT OR TORT (INCLUDING NEGLIGENCE), FOR INCIDENTAL, CONSEQUENTIAL, INDIRECT, SPECIAL, OR PUNITIVE DAMAGES OF ANY KIND, OR FOR LOSS OF REVENUE OR PROFITS, LOSS OF BUSINESS, LOSS OF INFORMATION OR DATA, OR OTHER FINANCIAL LOSS ARISING OUT OF OR IN CONNECTION WITH THE SALE, INSTALLATION, MAINTENANCE, USE, PERFORMANCE, FAILURE, OR INTERRUPTION OF ITS PRODUCTS, EVEN IF SHORETEL OR ITS AUTHORIZED RESELLER HAS BEEN ADVISED OF THE POSSIBILITY OF SUCH DAMAGES, AND LIMITS ITS LIABILITY TO REPAIR, REPLACEMENT, OR REFUND OF THE PURCHASE

PRICE PAID, AT SHORETEL'S OPTION. THIS DISCLAIMER OF LIABILITY FOR DAMAGES WILL NOT BE AFFECTED IF ANY REMEDY PROVIDED HEREIN SHALL FAIL OF ITS ESSENTIAL PURPOSE.

DISCLAIMER. Some countries, states, or provinces do not allow the exclusion or limitation of implied warranties or the limitation of incidental or consequential damages for certain products supplied to consumers, or the limitation of liability for personal injury, so the above limitations and exclusions may be limited in their application to you. When the implied warranties are not allowed to be excluded in their entirety, they will be limited to the duration of the applicable written warranty. This warranty gives you specific legal rights, which may vary depending on local law.

GOVERNING LAW. This Limited Warranty and Limitation of Liability shall be governed by the laws of the State of California, U.S.A., and by the laws of the United States, excluding their conflicts of laws principles. The United Nations Convention on Contracts for the International Sale of Goods is hereby excluded in its entirety from application to this Limited Warranty and Limitation of Liability.

Safety and Regulatory Information

FCC ID: K7G56C00A Canada IC: 2415B-S6C00A

U. S. FCC Intentional Radiator User Information

This device complies with Part 15 (C) of the FCC Rules. Operation is subject to the following two conditions:

- (1) This device may not cause harmful interference.
- (2) This device must accept any interference received, including interference that may cause undesired operation.

Note: This equipment has been tested and found to comply with the limits for an Intentional Radiator pursuant to Part 15(C) of the FCC rules. These limits are designed to provide reasonable protection against harmful interference when the equipment is operated in a residential or commercial environment. This equipment generates, uses and can radiate radio frequency energy and, if not installed and used in accordance with the instructions, may cause harmful interference to radio communications, in which event the user may be ordered to cease operation.

This Intentional Radiator apparatus complies with Canadian IC RS-210 and CS-03.

L'émetteur RF inclus dans cet appareil est conforme à la norme IC RSS-210 et CS-03 du Canada.

European Union: This device complies with the R&TTE Directive, 1999/5/EC.

FCC RF Radiation Exposure

This equipment complies with FCC radiation exposure limits set forth for an uncontrolled environment. End users must follow the specific operating instructions for satisfying RF exposure compliance. This transmitter must not be co-located or operating in conjunction with any other antenna or transmitter.

In accordance with part 15 of the FCC rules, the user is cautioned that any changes or modifications not expressly approved by ShoreTel, Inc. could void the user's authority to operate this equipment.

Installation must be performed in accordance with all relevant national wiring rules.

L'Installation doit être exécutée conformément à tous les règlements nationaux applicable au câblage électrique.

Copyright. All rights reserved under International and pan-American Copyright Conventions. No part of the contents of this manual may be copied, reproduced, or transmitted in any form or by any means, or translated into another language or format, in whole or part, without written consent of ShoreTel, Inc. ShoreTel® and the logo design are registered trademarks and ShoreTel® IP is a trademark of ShoreTel, Inc. in the United States, and various countries.

Do not remove (or allow any third party to remove) any product identification, copyright, or other notices. The software contained within this product is protected by United States copyright laws and international treaty provisions. ShoreTel, Inc., retains title and ownership of all property rights with respect to the software within this product.

